

GENERAL DIAGRAM OF COMET INPUT SOURCE REQUIREMENT

ACCEPTABLE SOURCES
(WITH SOLIDLY GROUNDED NEUTRAL)

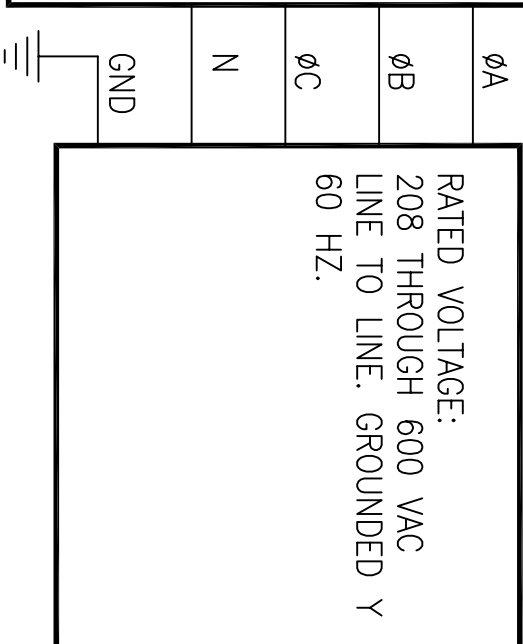
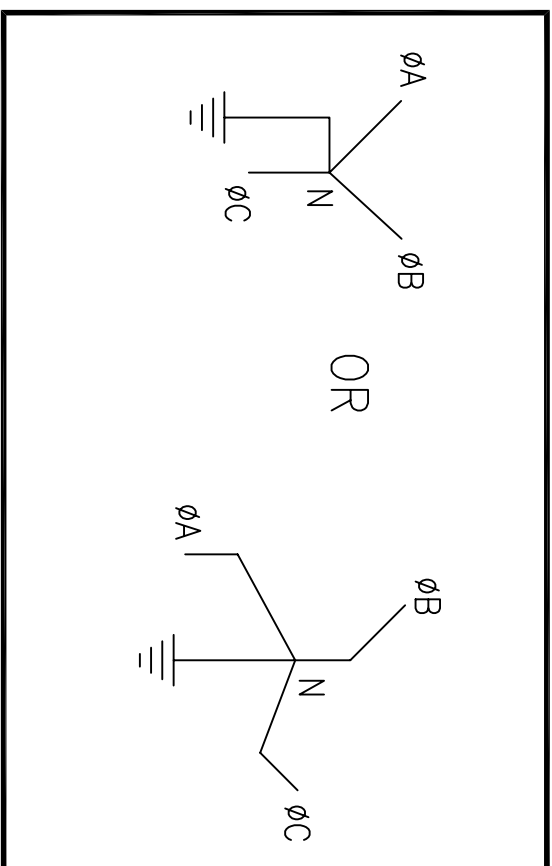

DISTRIBUTION BOARD

TRANSFORMER

COMET UPS (40-150 KVA)

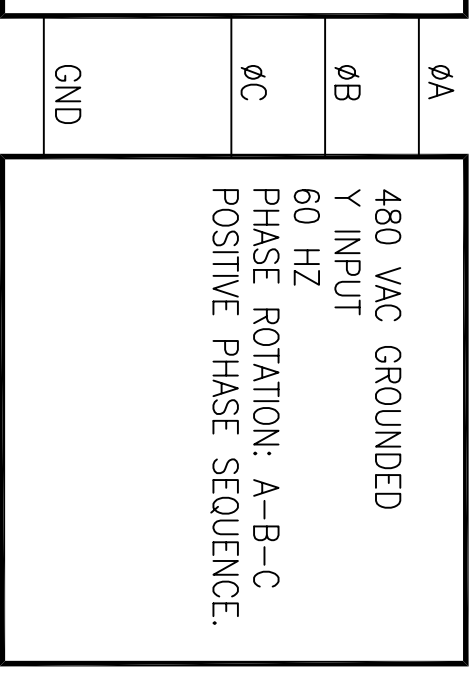
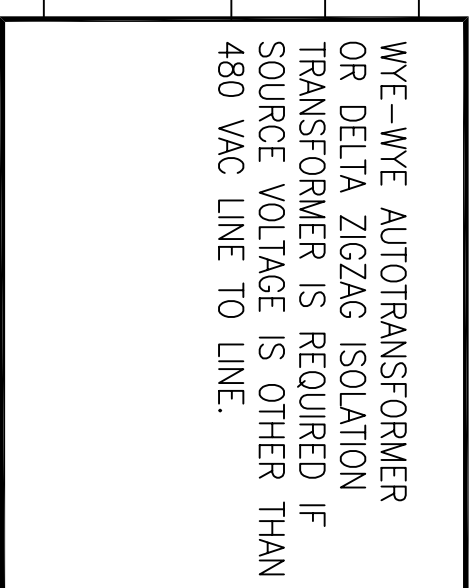

SOURCES THAT REQUIRE DELTA-WYE OR
DELTA ZIGZAG ISOLATION TRANSFORMER
TO FEED COMET UPS

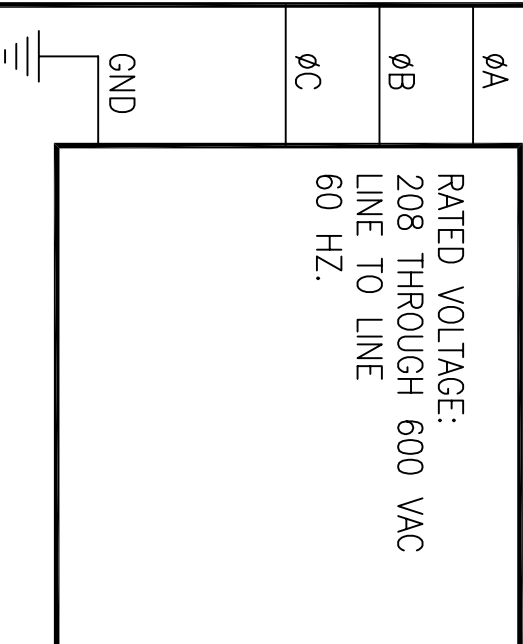
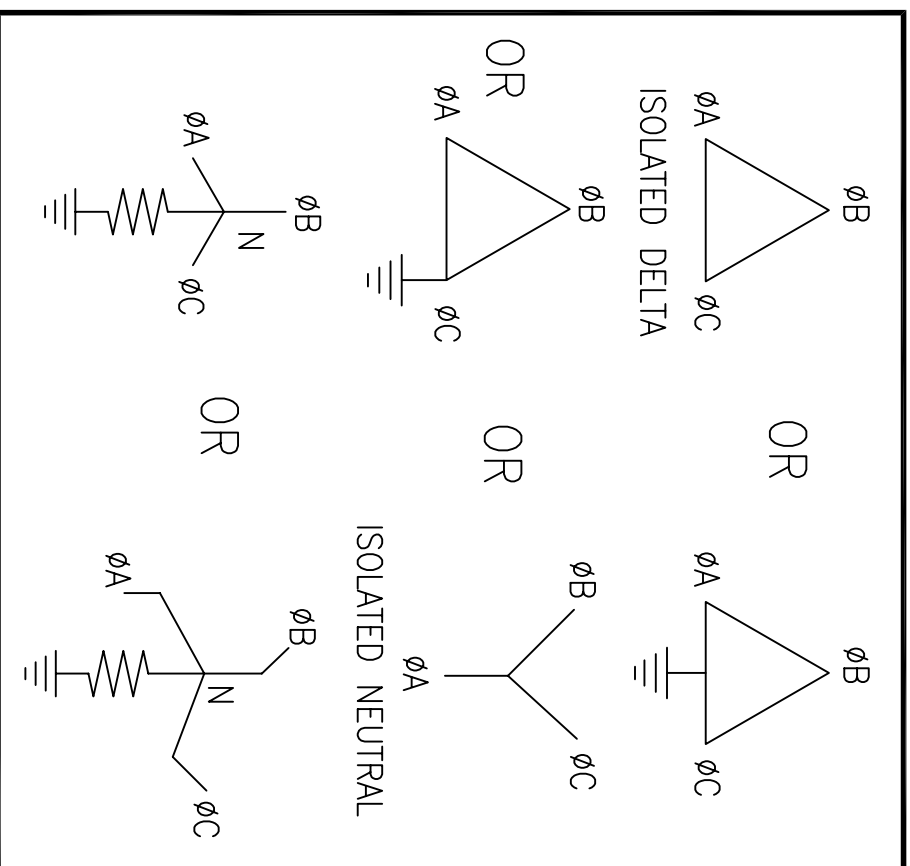

DISTRIBUTION BOARD

ISOLATION TRANSFORMER
DELTA-WYE OR DELTA-ZIGZAG

COMET UPS (40-150 KVA)

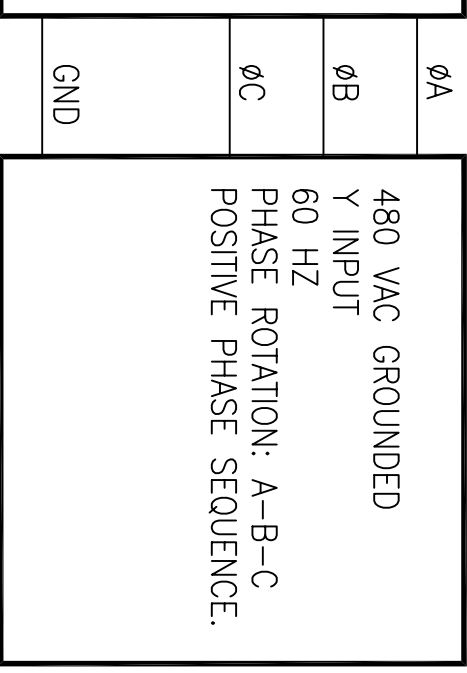
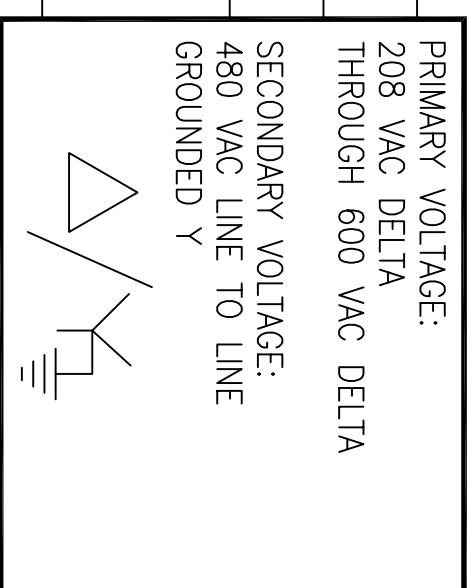

SIZE	CAGE CODE	DWG NO.	REV.
B	9L985	90-160080-00	E02
SCALE	NONE	CAD	SHEET 6 OF 7